



Nome del prodotto

## Dispositivo di separazione







Per l'estrazione di cuscinetti a sfere, cuscinetti a rulli, anelli interni e altre parti incastrate e a livello, quando non c'è abbastanza spazio per le griffe di estrazione.

Num. art. 15-2

Serie 15

EAN 4021176007118



	Attributo tecnico	Metrico	Imperiale
	Diametro dell'albero	22 - 115 mm	7/8 - 4 1/2 inch
	Distanza dei bulloni laterali	115 mm	4 1/2 inch
	Peso	2.9 kg	
	Spazio sotto	0 mm	0 inch
	Spazio adiacente	115 mm	4 1/2 inch
	Ampiezza di serraggio esterna	22 - 115 mm	7/8 - 4 1/2 inch
	Profondità di serraggio	250 mm	9 7/8 inch



esige anche

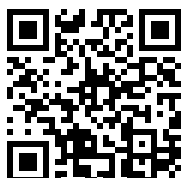

**Dispositivo di estrazione**

18-2

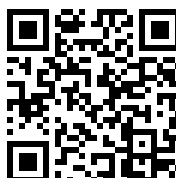

**Dispositivo di estrazione  
idraulico (inclusa vite  
meccanica)**

18-2-B



## Pezzo di ricambio

<b>Num. art.</b>	<b>Nome del prodotto</b>
015210	Bullone laterale con dado

## é parte di

<b>Num. art.</b>	<b>Nome del prodotto</b>
WT-008	Assortimento estrattori - Veicoli commerciali - BASIC
WT-010	Assortimento estrattori - Veicoli commerciali - TOP
15-B	Set dispositivi di separazione
30-20-T	Assortimento estrattori - Industria - BASIC
WT-50	Assortimento estrattori - Industria - TOP
K-20-15	Set di estrattori universali e dispositivi di separazione
29-B	Set di estrattori universali in TANOS-Systainer®
30-20+T	Assortimento estrattori - Industria - BASIC+



## é pezzo di ricambio di

<b>Num. art.</b>	<b>Nome del prodotto</b>
WT-008	Assortimento estrattori - Veicoli commerciali - BASIC
15-B	Set dispositivi di separazione
K-20-15	Set di estrattori universali e dispositivi di separazione
29-B	Set di estrattori universali in TANOS-Systainer®

## é incluso anche in

<b>Num. art.</b>	<b>Nome del prodotto</b>
WT-008	Assortimento estrattori - Veicoli commerciali - BASIC
WT-010	Assortimento estrattori - Veicoli commerciali - TOP
30-20-T	Assortimento estrattori - Industria - BASIC
WT-50	Assortimento estrattori - Industria - TOP
K-20-15	Set di estrattori universali e dispositivi di separazione
30-20+T	Assortimento estrattori - Industria - BASIC+

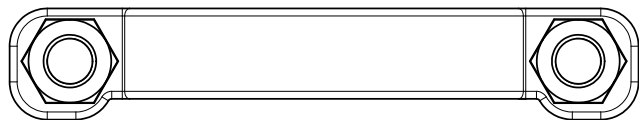
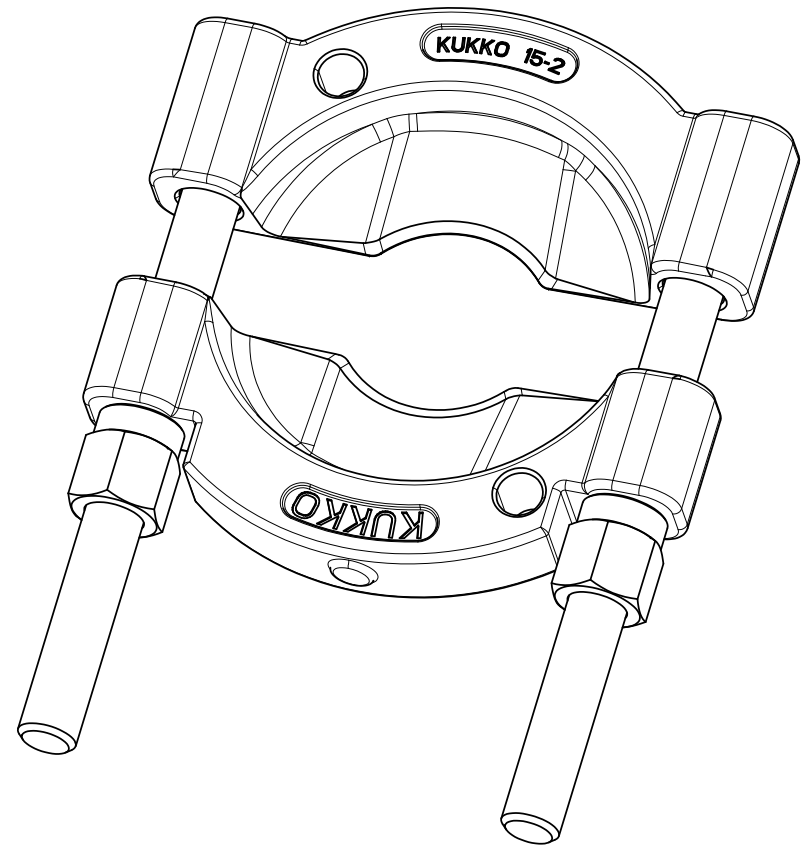
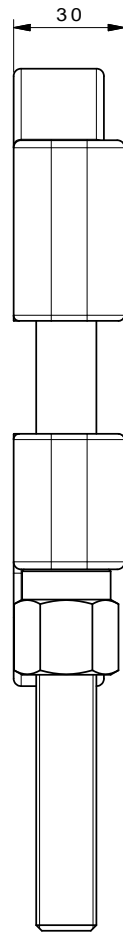
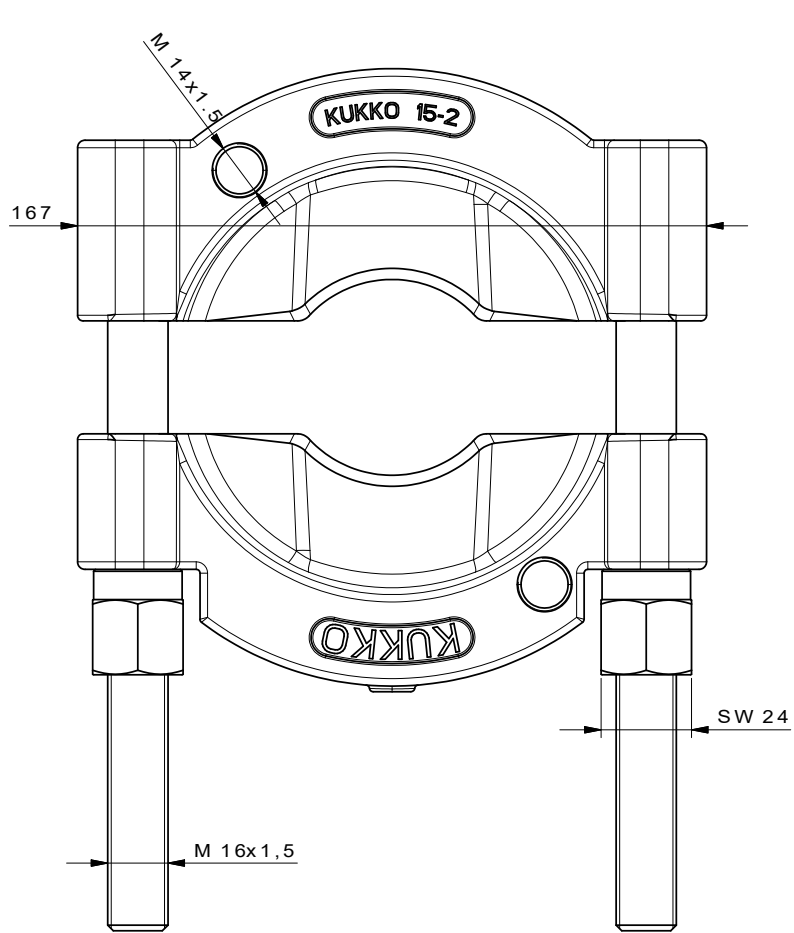

 <b>Kleinbongartz &amp; Kaiser oHG</b> Werkzeugfabrik Hilden - Germany	Dokumentname: 15-2_Trennvorrichtung	Toleranz: DIN ISO 2768-m
	Dokumentbeschreibung: Baugruppe	Material: Hoch legierter Werkzeugstahl / High alloy tool steel
	Erstellt von: Schultes	Erstellungsdatum: 08/04/2016
Teilbeschreibung: Trennvorrichtung / Separators		Wärmebehandlung / Härte: vergüteter Stahl/ tempered steel
		Oberflächenbehandlung:
Artikelnummer / ZNR.: 15-2	Dokumentversion: -	Schutzvermerk ISO 16016 beachten