



产品名称

分离器带快速夹紧压力主轴







用于在没有足够的空间使用拉马爪的情况下，拆卸滚珠轴承、滚子轴承、内圈等紧部件。

编号 17-3

系列 17

EAN 4021176008443



技术规格	公制	英制
 轴的直径	25 - 155 mm	1 - 6 1/8 inch
 螺柱间距	155 mm	6 1/8 inch
 重量	7.135 kg	
 下方空间	0 mm	0 inch
 邻近空间	155 mm	6 1/8 inch
 跨度	25 - 25 mm	1 - 1 inch
 深度	300 mm	11 7/8 inch



完整

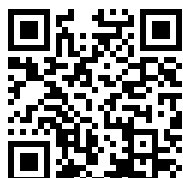

拉拔装置
18-3

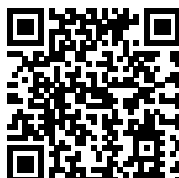

液压拉拔装置 (包含机械压
力螺钉)
18-3-B



配件

编号	产品名称
17-3-T	横梁
17-3-06	主轴
621170	机械压力主轴。
017322	带螺母的侧螺栓
621220	机械压力主轴。

部分

编号	产品名称
17-C	拆分套装带快速夹紧压力主轴

配件

编号	产品名称
17-C	拆分套装带快速夹紧压力主轴

SW 22

G 1/2"

KUKKO

17-3

KUKKO

210

36

KUKKO

17-3

KUKKO

KUKKO

M 18x1.5

SW 32

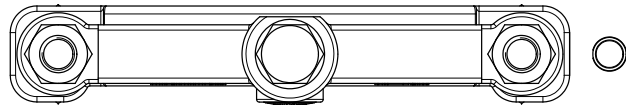
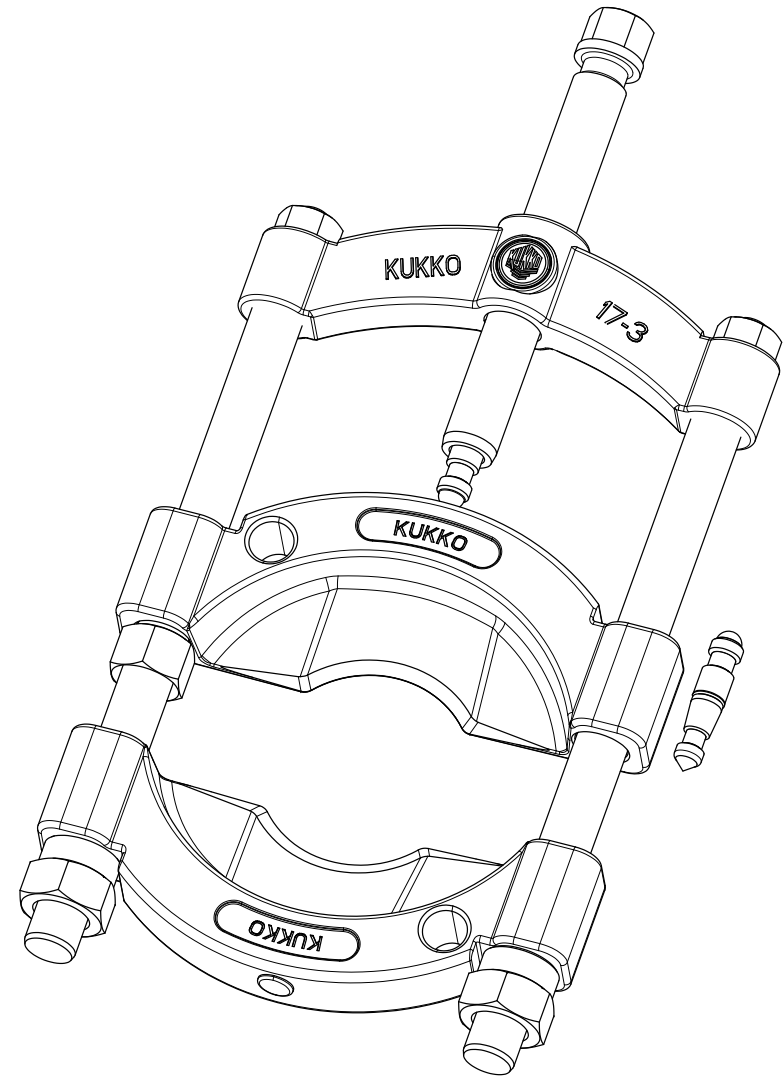

 Kleinbongartz & Kaiser oHG Werkzeugfabrik Hilden - Germany	Dokumentnr.: 17-3 Trennvorrichtung mit Spindel	Toleranz: DIN ISO 2768-m
	Dokumentbeschreibung: Baugruppe	Material: Hoch legierter Werkzeugstahl / High alloy tool steel
Erweit. von: Schultes	Erstellungsdatum: 12/04/2016	Maßstab: 1:1
Teilbeschreibung: Trennvorrichtung mit Schnellspanndruckspindel / Separator with quick clamping pressure spindle	Wärmebehandlung / Härte: vergüteter Stahl / tempered steel	Oberflächenbehandlung:
Artikelnummer / ZNR.: 17-3	Dokumentversion: -	Schutzvermerk: ISO 16949 zertifiziert