

Nome del prodotto

Estrattore universale a 2 bracci









Per l'estrazione di cuscinetti, ingranaggi, pulegge ecc.

Num. art. 20-20

Serie 20

EAN 4021176010088



	Attributo tecnico	Metrico	Imperiale
	Ampiezza di serraggio esterna	40 - 200 mm	1 5/8 - 7 7/8 inch
	Profondità di serraggio	150 mm	5 7/8 inch
	Ampiezza di serraggio interna	100 - 260 mm	3 7/8 - 10 1/4 inch
	Esagono esterno	22 mm	
max.	Carico massimo consentito	6,0 t	6.5 US t
	Coppia massima	150 Nm	110.5 ft lb
	Numero delle griffe	2	2
	Peso	3.22 kg	
	Spazio sotto	9 mm	3/8 inch
	Spazio adiacente	40 mm	1 5/8 inch



Tecnologie



SWITCH

Adattamento ottimale dei mandrini all'albero grazie alla punta bilaterale dei mandrini.



GLIDE & FIX

La geometria ottimizzata garantisce una scorrevolezza facile e rapida dei ganci di estrazione sulla traversa.



ARMLOCK

I ganci a croce garantiscono la massima stabilità per la sospensione dei ganci di estrazione nel pezzo scorrevole.



Pezzo di ricambio

Num. art.	Nome del prodotto
621220	Vite di pressione meccanica.
2-150-P	2 griffe (paio)
20-20-T	Traversa a 2 bracci

Acessori

Num. art.	Nome del prodotto
8-01	Vite idraulica lunga
2-300-P	2 griffe allungate (paio)
2-V-150-P	5 prolunghe di griffe (paio)
2-150-E	1 griffa di estrazione allungata (singola)
30-20-T3	Traversa a 3 bracci
K-600-025	Set di pressori intercambiabili per viti di pressione KUKKO



Utilizzi alternativi

Num. art.	Nome del prodotto
2-151-P	2 griffe sottili (paio)
2-301-P	2 griffe sottili (paio)
2-152-P	2 griffe a regolazione rapida (paio)
2-302-P	2 griffe a regolazione rapida (paio)
2-153-P	2 griffe sottili, a regolazione rapida (paio)
2-303-P	2 griffe sottili, a regolazione rapida (paio)

é parte di

Num. art.	Nome del prodotto
WT-008	Assortimento estrattori - Veicoli commerciali - BASIC
30-20-T	Assortimento estrattori - Industria - BASIC
20-ST	Display di vendita per estrattori a 2 bracci



é pezzo di ricambio di

Num. art.	Nome del prodotto
WT-008	Assortimento estrattori - Veicoli commerciali - BASIC
20-ST	Display di vendita per estrattori a 2 bracci

é incluso anche in

Num. art.	Nome del prodotto
WT-008	Assortimento estrattori - Veicoli commerciali - BASIC
30-20-T	Assortimento estrattori - Industria - BASIC
K-2030-20-B	Set di estrattori universali idraulici a 2 e 3 bracci
K-2030-20	Set di estrattori universali a 2 e 3 bracci

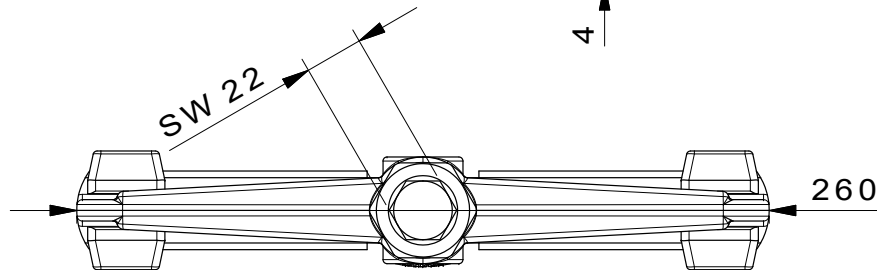
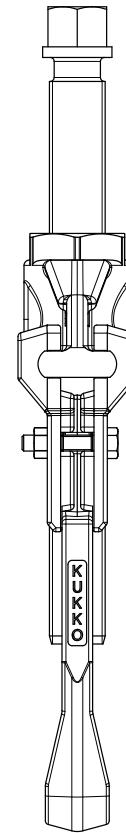
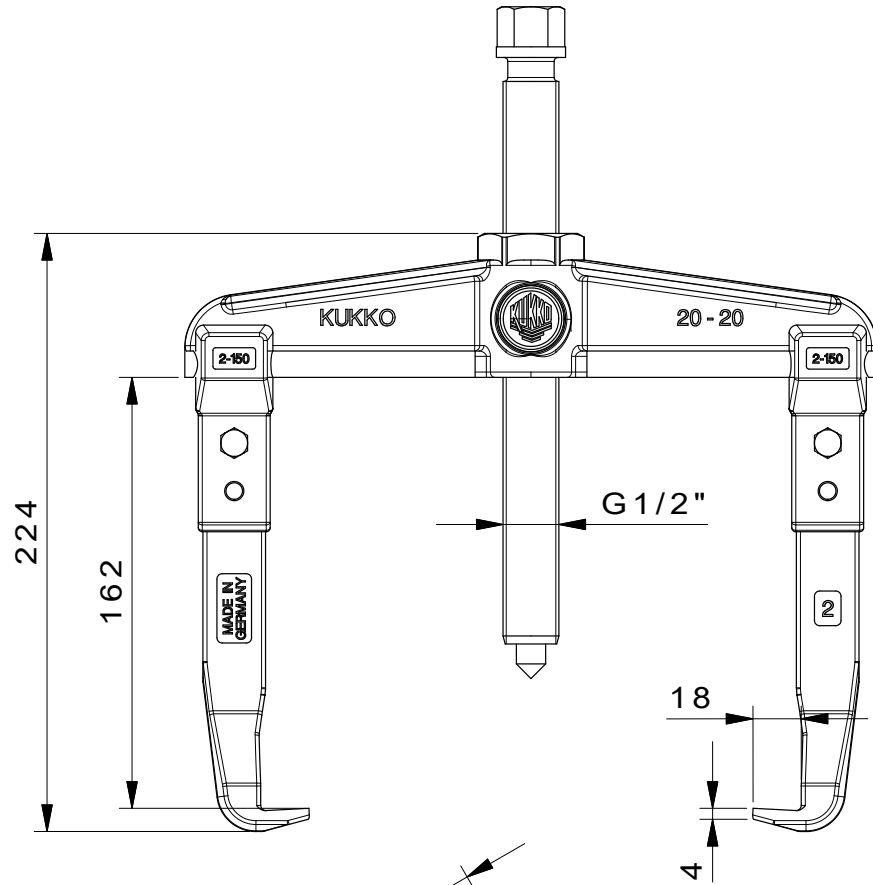
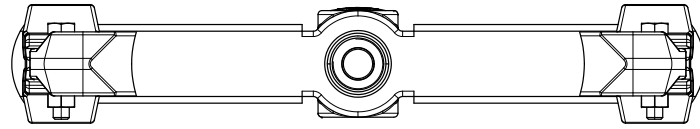

	Kleinbongartz & Kaiser oHG Werkzeugfabrik Hilden - Germany	Dokumentname: 20-20_2-Arm-Universal_Abzieher	Toleranz: DIN ISO 2768-m
	Dokumentbeschreibung: Baugruppe	Erweit. / Geprüft von: Schultes	Material: Hoch legierter Werkzeugstahl / High alloy tool steel
Teilbeschreibung: 2-Arm-Universal_Abzieher/ 2-jaw puller	Zeichnungsdatum: 30/03/2015	Maßstab: 1:1	Wärmebehandlung / Härte: vergüteter Stahl/ tempered steel
Artikelnummer / ZNR: 20-20	Dokumentversion: -	Schutzvermerk: ISO 16949 beachten	Oberflächenbehandlung: