



Ürün adı

2 kollu üniversal çekirme







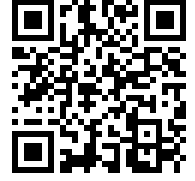

Yatakları, dişlileri, rondelaları vb. çıkarmak için.

Ürün No. 20-2

Seriler 20

EAN 4021176009501



	Teknik özellik	Metrik	Imparatorluk
	Açılma genişliği	40 - 160 mm	1 5/8 - 6 3/8 inch
	Derinlik	150 mm	5 7/8 inch
	İç çekirme açılma genişliği	100 - 220 mm	3 7/8 - 8 5/8 inch
	Altıköşe geçme (erkek)	22 mm	
max.	İzin verilen maksimum yük	6,0 t	6.5 US t
	Maks. tork	150 Nm	110.5 ft lb
	Çene sayısı	2	2
	Ağırlık	3.01 kg	
	Raum unterhalb	9 mm	3/8 inch
	Raum nebendran	40 mm	1 5/8 inch



Teknolojiler



SWITCH

İki taraflı mil ucu sayesinde milin şaftla optimum uyumu.



GLIDE & FIX

Optimal geometri çenenin giriş üzerinde kolayca ve hızlı kaydırılmasına izin verir.



ARMLOCK

Çapraz kancalar çenenin kayar parça içine asılmasında azami denge sağlar.



Yedek parça

Ürün No.	Ürün adı
621220	Mekanik mil
2-150-P	2 çektirme kolu (çift)
20-2-T	2 kollu gövde

Aksesuarlar

Ürün No.	Ürün adı
8-01	Uzun hidrolik mil
2-300-P	2 ve 3 parçalı iç çektirme kolu (çift)
2-V-150-P	2 çekme kolu uzatması (çift)
2-150-E	1 uzatılmış çektirme kolu (tek)
30-2-T	3 kollu çektirme gövdesi
K-600-025	KUKKO Milleri için, "6'sı 1 arada" değiştirilebilir Mil Uç Geçme Parçaları



Alternatif olarak birlikte kullanılabilir

Ürün No.	Ürün adı
2-151-P	2 dar çekirme kolu (çift)
2-301-P	2 dar çekirme kolu (çift)
2-152-P	2 hızlı ayarlanabilir çekirme kolu (çift)
2-302-P	2 hızlı ayarlanabilir çekirme kolu (çift)
2-153-P	2 dar ve ayarlanabilen çekirme kolu (çift)
2-303-P	2 dar ve ayarlanabilen çekirme kolu (çift)

Parçasıdır

Ürün No.	Ürün adı
24-B	Rulman çekirme ve çıkartma seti
24-C	Rulman çekirme ve çıkartma seti
20-ST	2 kollu çekirme için satışa uygun pano



In yedek parçası

Ürün No.	Ürün adı
24-B	Rulman çekirme ve çıkartma seti
24-C	Rulman çekirme ve çıkartma seti
K-20-15	Üniversal çekirme ve ayırıcı seti
20-ST	2 kollu çekirme için satışa uygun pano

De içinde bulunur

Ürün No.	Ürün adı
K-20-15	Üniversal çekirme ve ayırıcı seti

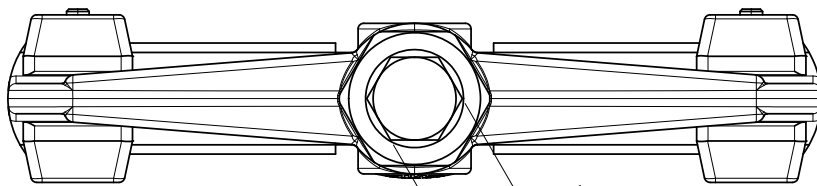
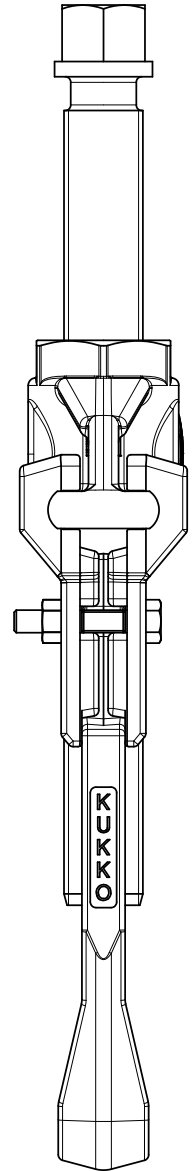
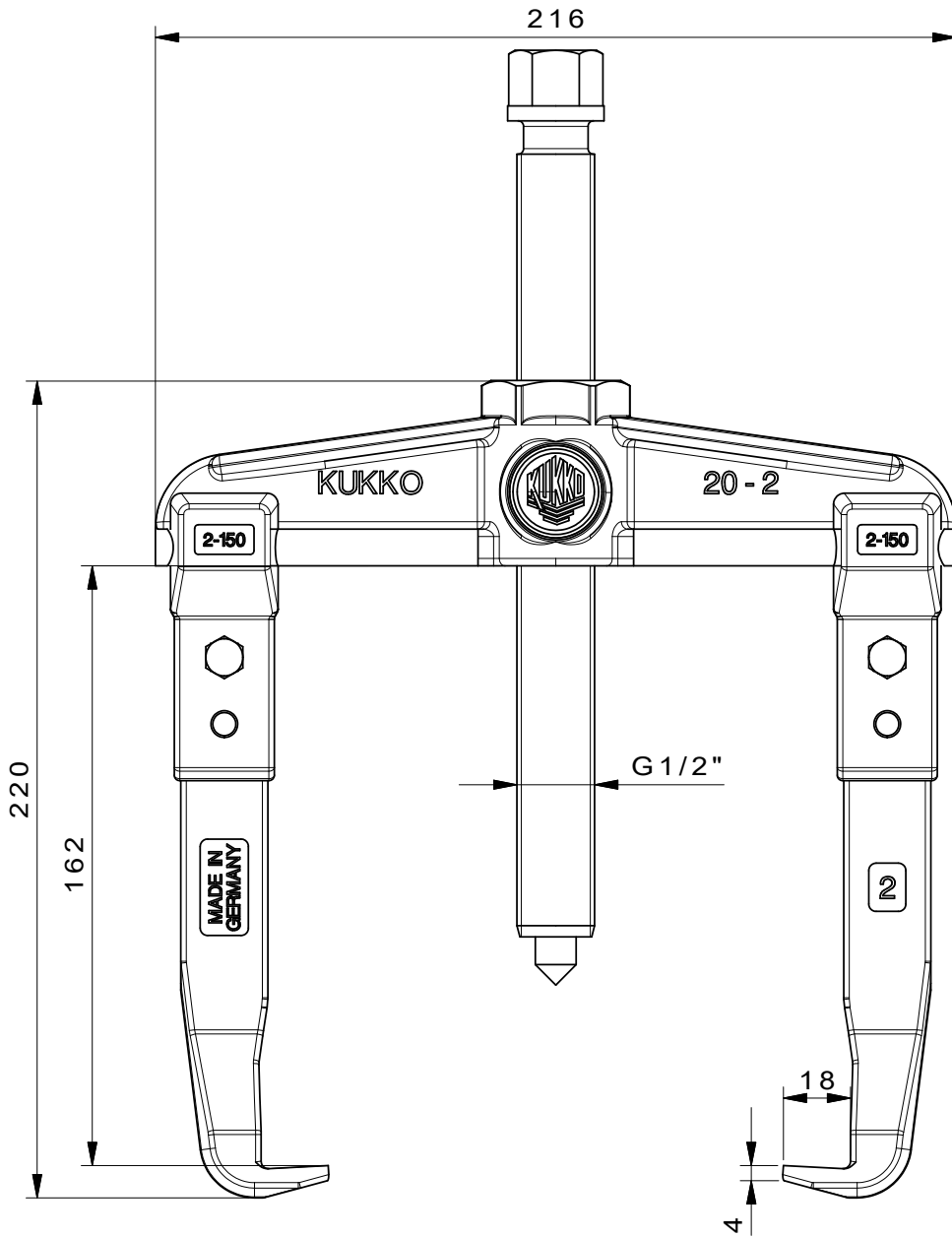
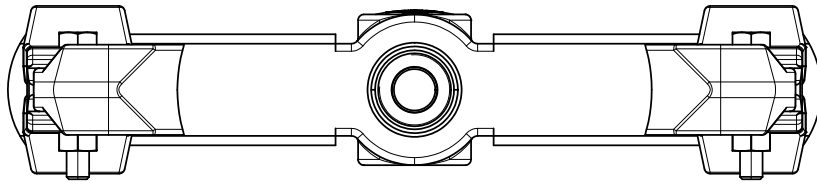

SW 22

 Kleinbongartz & Kaiser oHG Werkzeugfabrik Hilden - Germany	Dokumentname: 20-2_2-Arm-Universal_Abzieher		Toleranz: DIN ISO 2768-m
	Dokumentbeschreibung: Baugruppe		Material: Hoch legierter Werkzeugstahl / High alloy tool steel
Teilbeschreibung: 2-Arm-Universal_Abzieher/ 2-jaw puller	Erstellt / Geprüft von: Schultes	Erstellungsdatum: 30/03/2015	Maßstab: 1:1
Artikelnummer / ZNR: 20-2	Dokumentversion: -	Wärmebehandlung / Härte: vergüteter Stahl/ tempered steel Oberflächenbehandlung:	
		Schutzvermerk ISO 16016 beachten	