



Ürün adı

## 2 kollu üniversal çekirme









Yatakları, dişlileri, rondelaları vb. çıkarmak için.

Ürün No. 20-30

Seriler 20

EAN 4021176010163



	<b>Teknik özellik</b>	<b>Metrik</b>	<b>İmparatorluk</b>
	Açılma genişliği	65 - 350 mm	2 5/8 - 13 3/4 inch
	Derinlik	200 mm	7 7/8 inch
	İç çekirme açılma genişliği	180 - 440 mm	7 1/8 - 17 3/8 inch
	Altıköşe geçme (erkek)	27 mm	
max.	İzin verilen maksimum yük	8,5 t	9 US t
	Maks. tork	300 Nm	221 ft lb
	Çene sayısı	2	2
	Ağırlık	7.525 kg	
	Raum unterhalb	20 mm	3/4 inch
	Raum nebendran	67 mm	2 5/8 inch



## Teknolojiler



### SWITCH

İki taraflı mil ucu sayesinde milin şaftla optimum uyumu.



### GLIDE & FIX

Optimal geometri çenenin giriş üzerinde kolayca ve hızlı kaydırılmasına izin verir.



### ARMLOCK

Çapraz kancalar çenenin kayar parça içine asılmasında azami denge sağlar.



## Yedek parça

Ürün No.	Ürün adı
626300	Mekanik mil
3-200-P	2 çekirme kolu (çift)
20-30-T	2 kollu gövde

## Aksesuarlar

Ürün No.	Ürün adı
8-02	Uzun hidrolik mil
9-1	Yardımcı hidrolik koç
9-2	Yardımcı hidrolik koç
9-3	Yardımcı hidrolik koç
3-300-P	2 ve 3 parçalı iç çekirme kolu (çift)
3-400-P	2 ve 3 parçalı iç çekirme kolu (çift)
3-500-P	2 ve 3 parçalı iç çekirme kolu (çift)
3-250-P	2 çekirme kolu (çift)
30-30-T	Gövde
K-600-025	KUKKO Milleri için, "6'sı 1 arada" değiştirilebilir Mil Uç Geçme Parçaları



## Alternatif olarak birlikte kullanılabilir

Ürün No.	Ürün adı
3-201-P	2 dar çekirme kolu (çift)
3-301-P	2 dar çekirme kolu (çift)
3-401-P	2 dar çekirme kolu (çift)
3-501-P	2 dar çekirme kolu (çift)
3-202-P	2 hızlı ayarlanabilir çekirme kolu (çift)
3-302-P	2 hızlı ayarlanabilir çekirme kolu (çift)
3-402-P	2 hızlı ayarlanabilir çekirme kolu (çift)
3-502-P	2 hızlı ayarlanabilir çekirme kolu (çift)
3-203-P	2 dar ve ayarlanabilen çekirme kolu (çift)
3-303-P	2 dar ve ayarlanabilen çekirme kolu (çift)
3-403-P	2 dar ve ayarlanabilen çekirme kolu (çift)
3-503-P	2 dar ve ayarlanabilen çekirme kolu (çift)

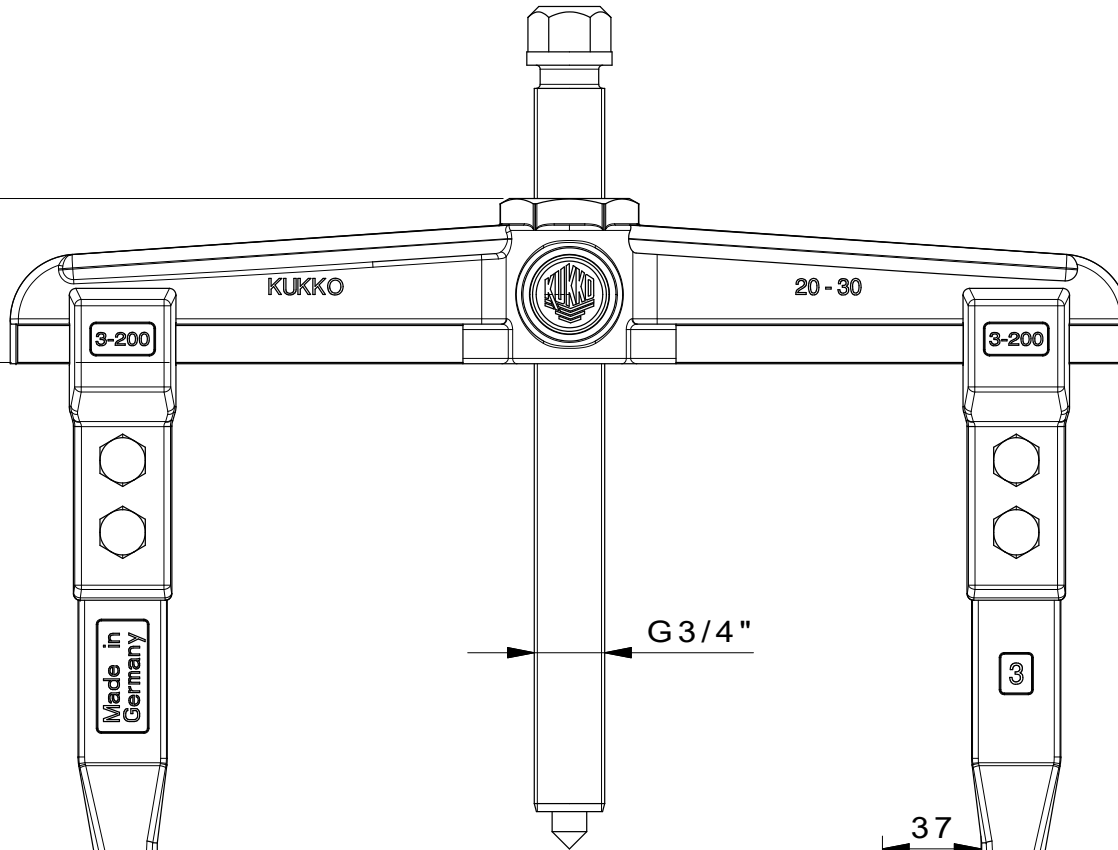
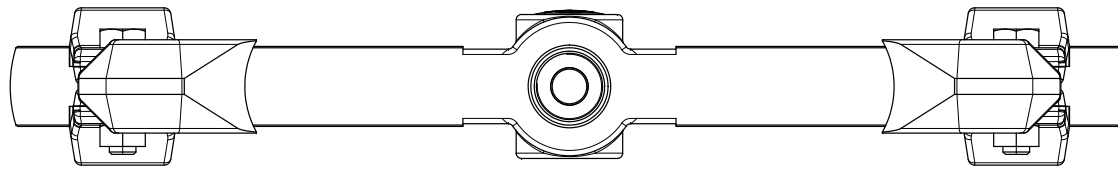

288

210

G 3/4"

37

4

SW 27

420

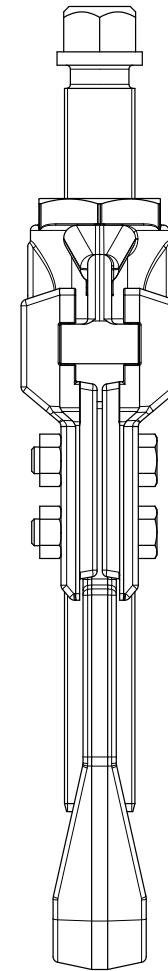

 <b>Kleinbongartz &amp; Kaiser oHG</b> Werkzeugfabrik Hilden - Germany	Dokumentname: 20-30_2-Arm-Universal_Abzieher	Toleranz: DIN ISO 2768-m
	Dokumentbeschreibung: Baugruppe	Material: Hoch legierter Werkzeugstahl / High alloy tool steel
Erstellt / Geprüft von: Schultes	Zeichnungsdatum: 30/03/2015	Maßstab: 1:1
Teilbeschreibung: 2-Arm-Universal_Abzieher/ 2-jaw puller	Wärmebehandlung / Härte: vergüteter Stahl/ tempered steel	Oberflächenbehandlung: 
Artikelnummer / ZNR: 20-30	Dokumentversion: -	Schutzvermerk: ISO 16949 zertifiziert