



Produktnavn \*

## 2-armet indvendig udtrækker







Til udtrækning af indvendige lejer, lejeyderringe og bøsninger.

Varenr. 21-0

Serie 21

EAN 4021176010408



	<b>Teknisk egenskab</b>	<b>Metrisk</b>	<b>Tomme</b>
	Kugleleje ISO	625; 635; 626; 607; 627; 608; 619/8; 628/8	625; 635; 626; 607; 627; 608; 619/8; 628/8
	Kuglelejets indvendige diameter	5 - 8 mm	1/4 - 3/8 inch
	Monteringsdybde	14 mm	5/8 inch
	Længde af indvendig udtrækker	73 mm	2 7/8 inch
	Antal segmenter	2	2
	Vægt	0.115 kg	



## Skal udføres med



### **Glidehammeranordning**

22-0

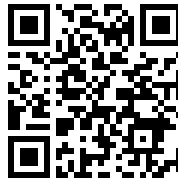

### **Modstøtter**

22-1



## Tilbehør

Varenr.	Produktnavn
21-V-040	Forlængelse til indvendige aftrækkere
21-V-0	Sæt forlængelser til indvendige aftrækkere

## Gå med

Varenr.	Produktnavn
22-1	Modstøtter

## Er bestanddel af

Varenr.	Produktnavn
EVLW-2-INDUSTRIE	Salgsvæg industri
EVLW-INDUSTRIE BASIC	Salgsvæg industri

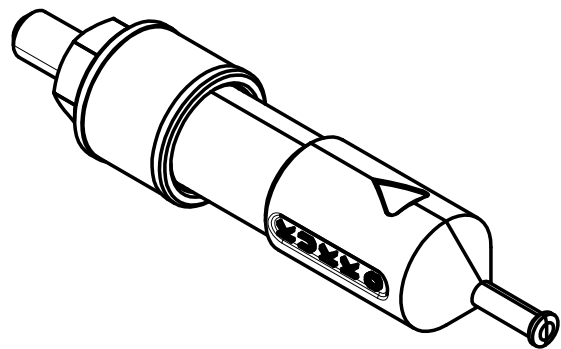
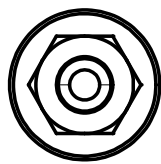
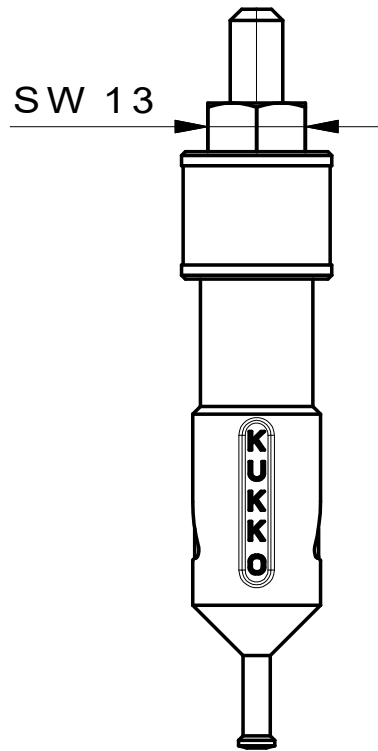
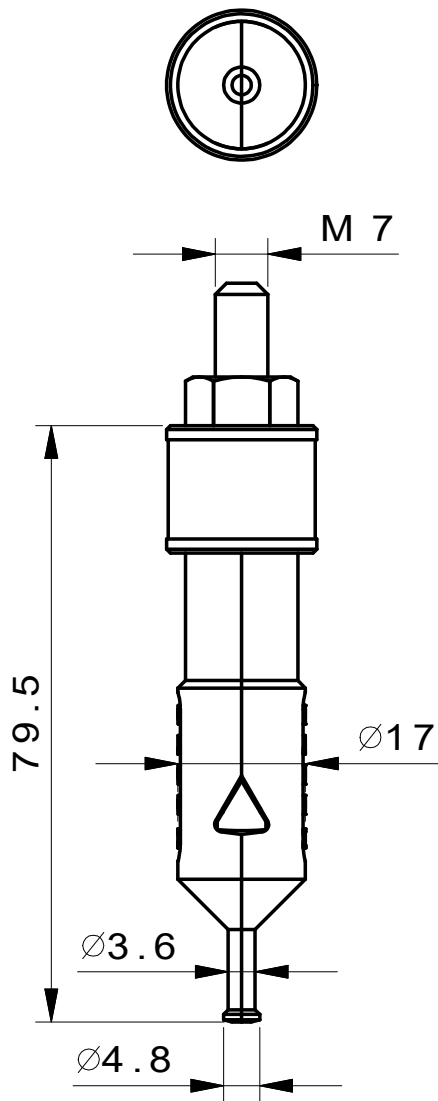

**Kleinbongartz  
& Kaiser  
oHG**  
Werkzeugfabrik  
Hilden - Germany

Dokumentname:  
21-0 Innenauszieher

Toleranz:  
DIN ISO 2768-m

Dokumentbeschreibung:  
ZSB

Material:  
Hochfester extra zäher Vergütungsstahl/  
High tensile strength and toughness steel

Erstellt / Geprüft von:  
Schultes

Erstellungsdatum:  
05/06/2015

Maßstab:  
1:1

Teilbeschreibung:  
Innenauszieher/ Internal extractor

Wärmebehandlung / Härte:  
vergüteter Stahl/ tempered steel

Oberflächenbehandlung:

Artikelnummer / ZNR.:  
21-0

Dokumentversion:  
-

Schutzvermerk  
ISO 16016  
beachten