



Nome del prodotto *

Estrattore interno a 2 strati







Per l'estrazione di cuscinetti interni, anelli di cuscinetti e bocche.

Num. art. 21-0

Serie 21

EAN 4021176010408



	Attributo tecnico	Metrico	Imperiale
	Cuscinetto a sfera ISO	625; 635; 626; 607; 627; 608; 619/8; 628/8	625; 635; 626; 607; 627; 608; 619/8; 628/8
	Diametro interno del cuscinetto a sfere	5 - 8 mm	1/4 - 3/8 inch
	Profondità di inserimento	14 mm	5/8 inch
	Lunghezza estrattore interno	73 mm	2 7/8 inch
	Numero di segmenti	2	2
	Peso	0.115 kg	



esige anche

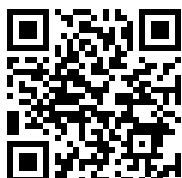

Dispositivi battenti

22-0

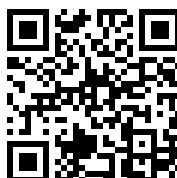

Controsupporti

22-1



Acessori

Num. art.	Nome del prodotto
21-V-040	Prolunga per estrattore interno
21-V-0	Set di prolunghe per estrattore interno

Viene utilizzato da

Num. art.	Nome del prodotto
22-1	Controsupporti

é parte di

Num. art.	Nome del prodotto
EVLW-2-INDUSTRIE	Display di vendita Industria
EVLW-INDUSTRIE BASIC	Display di vendita Industria

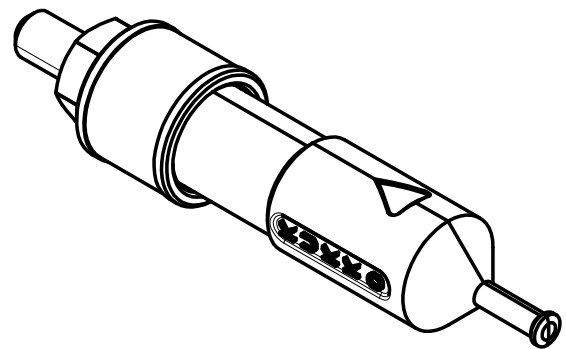
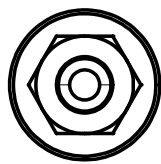
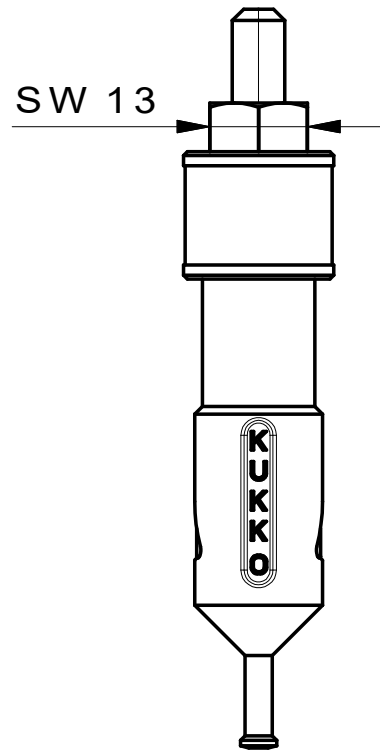
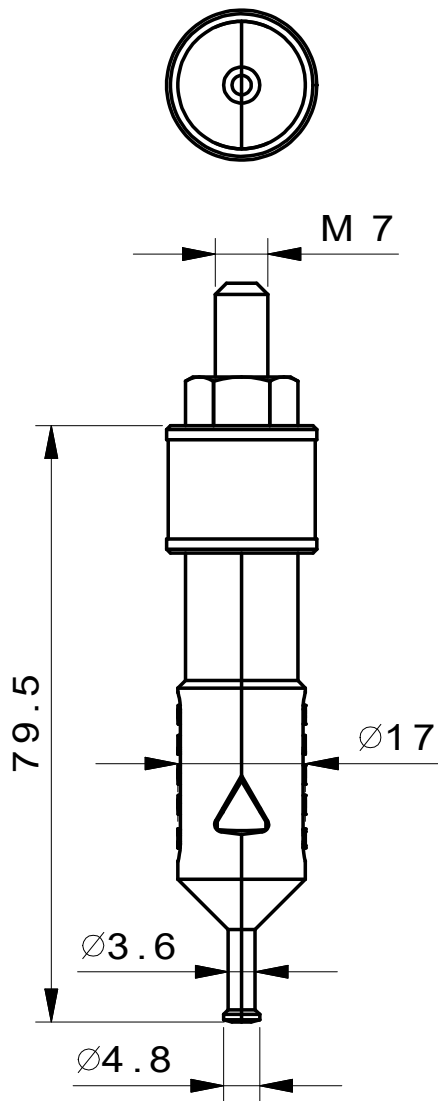

**Kleinbongartz
& Kaiser
oHG**
Werkzeugfabrik
Hilden - Germany

Dokumentname:
21-0 Innenauszieher

Toleranz:
DIN ISO 2768-m

Dokumentbeschreibung:
ZSB

Material:
Hochfester extra zäher Vergütungsstahl/
High tensile strength and toughness steel

Erstellt / Geprüft von:
Schultes

Erstellungsdatum:
05/06/2015

Maßstab:
1:1

Teilbeschreibung:
Innenauszieher/ Internal extractor

Wärmebehandlung / Härte:
vergüteter Stahl/ tempered steel

Oberflächenbehandlung:

Artikelnummer / ZNR.:
21-0

Dokumentversion:
-

Schutzvermerk
ISO 16016
beachten