



Nome do produto *

Extrator interno de 2 camadas







Para extrair rolamentos interiores, anéis exteriores de rolamentos e buchas.

Artigo Nº 21-0

Série 21

EAN 4021176010408



Características	Métrico	Polegada
 Rolamento de esferas ISO	625; 635; 626; 607; 627; 608; 619/8; 628/8	625; 635; 626; 607; 627; 608; 619/8; 628/8
 Diâmetro interno do rolamento	5 - 8 mm	1/4 - 3/8 inch
 Profundidade de utilização	14 mm	5/8 inch
 Comprimento do extrator interno	73 mm	2 7/8 inch
 Número de segmentos	2	2
 Peso	0.115 kg	



ainda necessita de

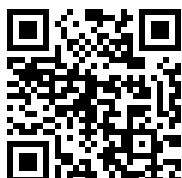

**Equipamento de martelo
deslizante**

22-0



Suportes

22-1



Acessórios

Artigo Nº	Nome do produto
21-V-040	Extensões para extratores interiores
21-V-0	Conjunto extensões para extratores interiores

é necessitado por

Artigo Nº	Nome do produto
22-1	Suportes

Faz parte de

Artigo Nº	Nome do produto
EVLW-2-INDUSTRIE	Parede de vendas setor
EVLW-INDUSTRIE BASIC	Parede de vendas setor

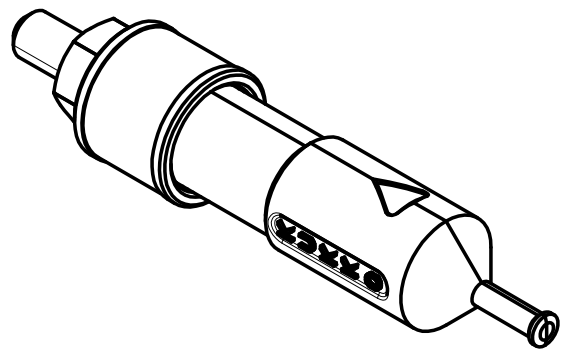
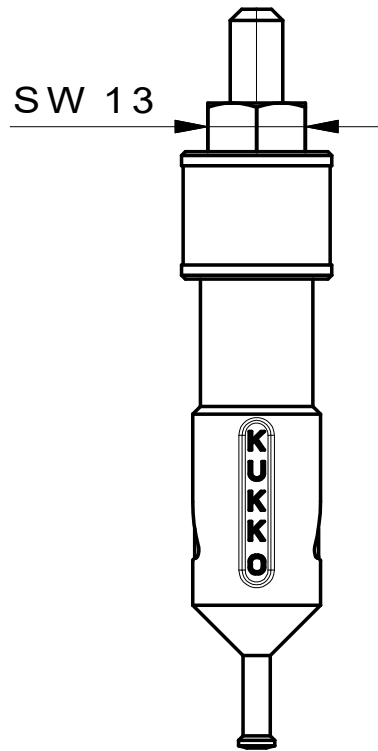
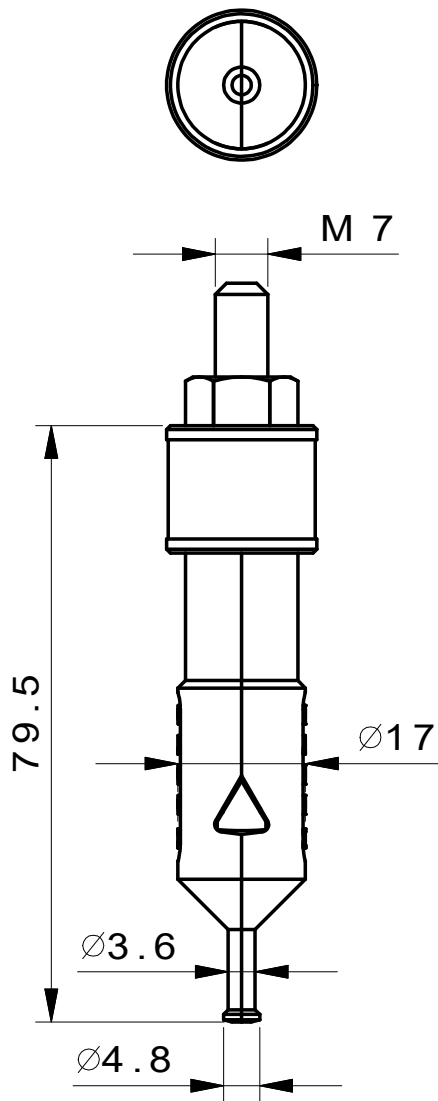

**Kleinbongartz
& Kaiser
oHG**
Werkzeugfabrik
Hilden - Germany

Dokumentname:
21-0 Innenauszieher

Toleranz:
DIN ISO 2768-m

Dokumentbeschreibung:
ZSB

Material:
Hochfester extra zäher Vergütungsstahl/
High tensile strength and toughness steel

Erstellt / Geprüft von:
Schultes

Erstellungsdatum:
05/06/2015

Maßstab:
1:1

Teilbeschreibung:
Innenauszieher/ Internal extractor

Wärmebehandlung / Härte:
vergüteter Stahl/ tempered steel

Oberflächenbehandlung:

Artikelnummer / ZNR.:
21-0

Dokumentversion:
-

Schutzvermerk
ISO 16016
beachten