



Nome del prodotto

## Estrattore interno con angoli di presa segmentati







Per l'estrazione di cuscinetti, anelli di cuscinetti e bocche che giacciono in piano.

Num. art. 21-3-E

Serie 21-E

EAN 4021176931109



|  | Attributo tecnico                              | Metrico  | Imperiale  |
|--|--|--|--|
|  | Cuscinetto a sfera ISO                         | 6004; 6204; 6304;<br>6404; 6804; 6904;<br>16004; 61804;<br>61904 | 6004; 6204; 6304;<br>6404; 6804; 6904;<br>16004; 61804;<br>61904 |
|  | Diametro interno del cuscinetto a sfere        | 18 - 23 mm   | 3/4 - 7/8 inch   |
|  | Profondità di inserimento                      | 50 mm  | 2 inch   |
|  | Lunghezza estrattore interno                   | 90 mm  | 3 1/2 inch   |
|  | Numero di segmenti                             | 3  | 3  |
|  | Larghezza della chiave dell'estrattore interno | 22 mm  |  |
|  | Peso   | 0.21 kg  |  |



esige anche

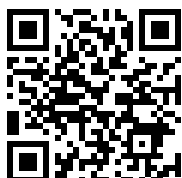

**Dispositivi battenti**

22-0

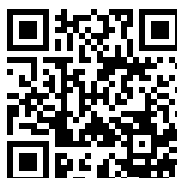

**Dispositivi battenti**

22-0-1



**Controsupporti**

22-1



**Controsupporti**

22-2



## Viene utilizzato da

| <b>Num. art.</b> | <b>Nome del prodotto</b> |
|------------------|--------------------------|
| 22-1             | Controsupporti           |
| 22-2             | Controsupporti           |

## é parte di

| <b>Num. art.</b> | <b>Nome del prodotto</b>  |
|------------------|---|
| 27-A             | Set di estrattori universali  |
| K-22-C-E         | Estrattore per cuscinetti a sfere in Set con controsupporti e estrattore a battente |
| K-22-B-E         | Estrattore per cuscinetti a sfere in Set con controsupporti e estrattore a battente |
| WT-017           | Assortimento estrattori - Estrazione interna - BASIC                                |

## é pezzo di ricambio di

| <b>Num. art.</b> | <b>Nome del prodotto</b>     |
|------------------|------------------------------|
| 27-A             | Set di estrattori universali |

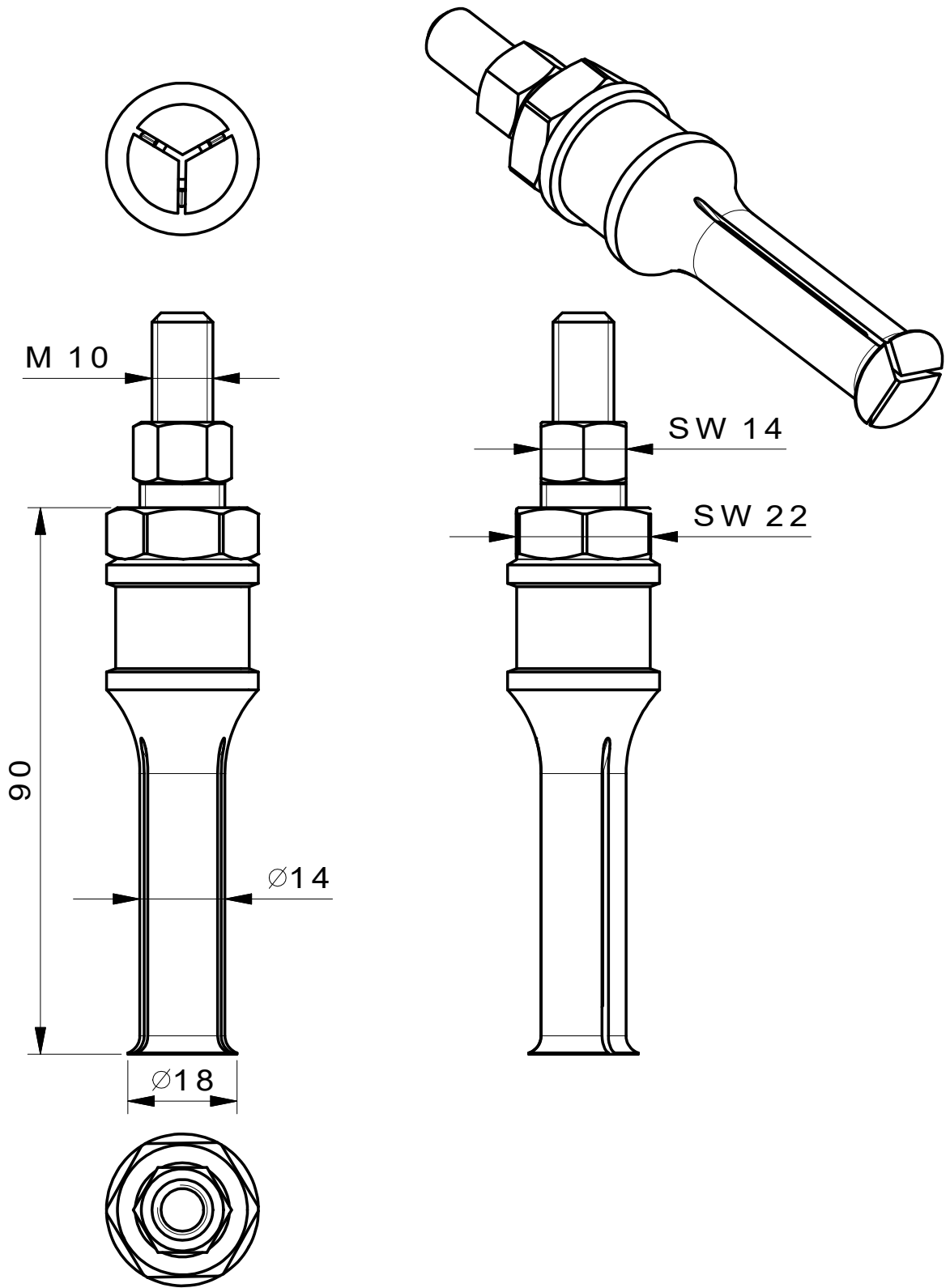

|  |   |                                 |   |  |
|--|---|---------------------------------|---|--|
|  <p><b>Kleinbongartz &amp; Kaiser oHG</b><br/>Werkzeugfabrik<br/>Hilden - Germany</p> | Dokumentname:<br>21-3-E_Segmentinnenauszieher |                                 | Toleranz:<br>DIN ISO 2768-m   |  |
|  | Dokumentbeschreibung:<br>Baugruppe            |                                 | Material:<br>Hochfester extra zäher Vergütungsstahl/<br>High tensile strength and toughness steel |  |
|  | Erstellt / Geprüft von:<br>Schultes           | Erstellungsdatum:<br>21/09/2015 | Maßstab:<br>1:1   |  |
| Teilbeschreibung:<br>Segment-Innenauszieher/ Internal extractor with segmented grasp edge  |   |                                 | Wärmebehandlung / Härte:<br>vergüteter Stahl/ tempered steel                                      |  |
|  |   |                                 | Oberflächenbehandlung:  |  |
| Artikelnummer / ZNR.:<br>21-3-E  | Dokumentversion:<br>-                         |                                 | Schutzvermerk<br>ISO 16016<br>beachten  |  |