



Nombre del producto

Extractores de cojinetes agujas





Para expulsar rodamientos de agujas, cojinetes y anillos exteriores de rodamiento que disponen de poca o ninguna contrasalida.

Núm. art. 21-44-E

Serie 21-4x-E

EAN 4021176039300



	Atributo técnico	Métrico	Imperial
	Diámetro interior del rodamiento de bolas	15 - 20 mm	5/8 - 3/4 inch
	Profundidad de uso	50 mm	2 inch
	Longitud del expulsor interno	90 mm	3 1/2 inch
 Segment	Número de segmentos	3	3
	Peso	0.2 kg	



necesita de

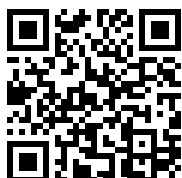

Martillo de correa

22-0



Martillo de correa

22-0-1



Contraapoyo

22-1



Contraapoyo

22-2



Es parte de

Núm. art.

Nombre del producto

27-A

Juego de extractores universales

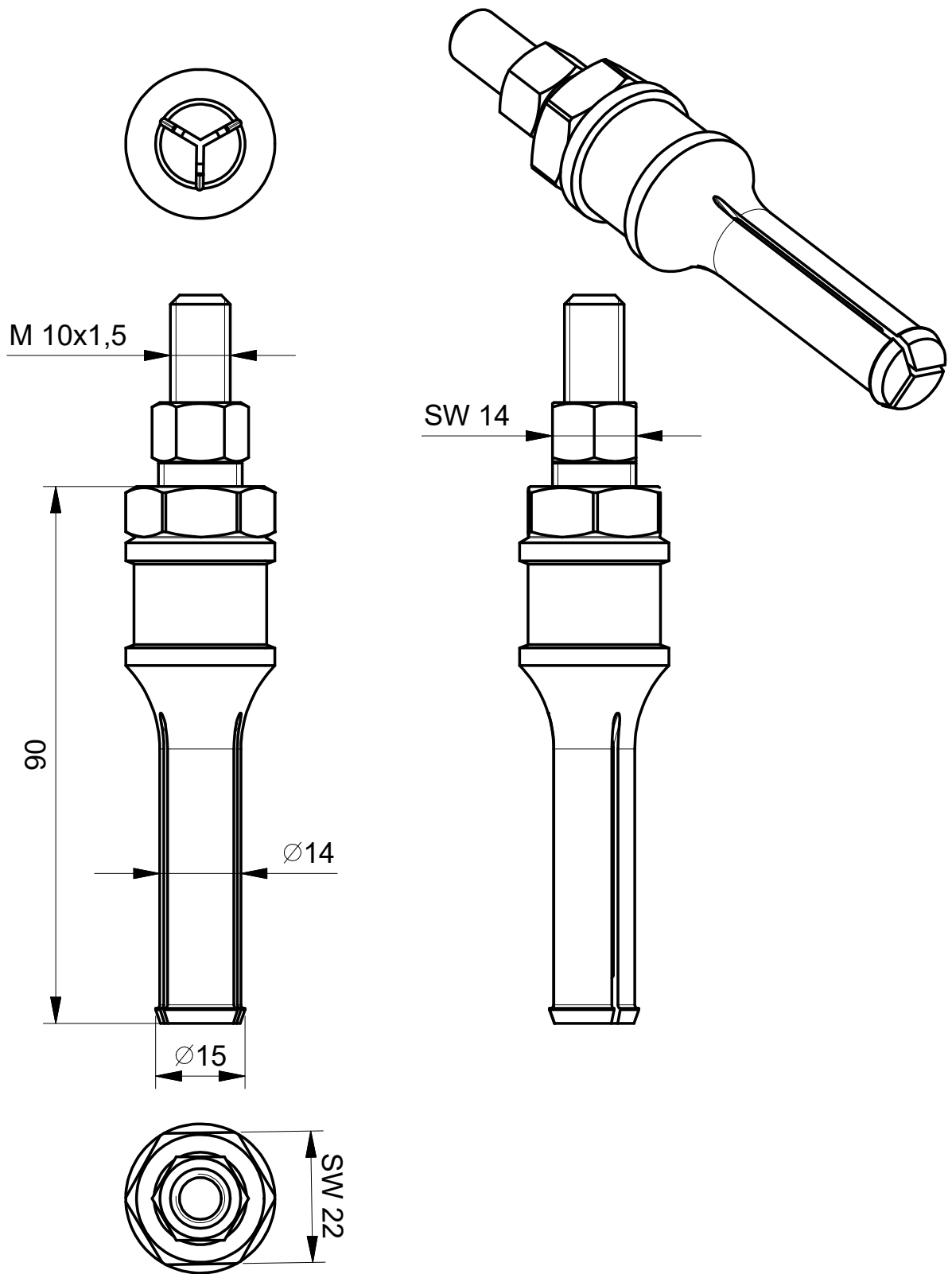

 <p>Kleinbongartz & Kaiser oHG Werkzeugfabrik Hilden - Germany</p>	Dokumentname: 21-3-E_Segmentinnenauszieher		Toleranz: DIN ISO 2768-m	
	Dokumentbeschreibung: Baugruppe		Material: Hochfester extra zäher Vergütungsstahl/ High tensile strength and toughness steel	
	Erstellt / Geprüft von: Schultes	Erstellungsdatum: 21/09/2015	Maßstab: 1:1	
Teilbeschreibung: Nadellager-Innenauszieher/ Internal extractor with segmented grasp edge			Wärmebehandlung / Härte: vergüteter Stahl/ tempered steel	
			Oberflächenbehandlung:	
Artikelnummer / ZNR.: 21-44-E	Dokumentversion: -		Schutzvermerk ISO 16016 beachten	