



Nom du produit

Vis hydraulique longue





Pour le retrait de roulements, de cames, de disques, etc. particulièrement grippés.

Réf. 8-2-M

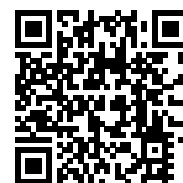
Gammes 8

Code à barre 4021176034916



	Caractéristique technique	Métrique	Impérial
	Longueur du filetage de la vis hydraulique	350 mm	13 3/4 inch
	Filetage	G 1 1/8"	G 1 1/8"
	Course	10 mm	3/8 inch
max.	Charge maximale admissible	20 t	22 US t
 max.	Moment de couple max.	30 Nm	22 ft lb
	Poids	11.14 kg	



Technologies



HYDRAULIQUE

Outils d'extraction avec fonction hydraulique.



Pièce de rechange

Réf.	Nom du produit
8-2	Hydraulique pour vis
8-M	Vis creuse 350 mm pour 8-2
8-2-ERS	Jeu de pièces d'usure

Pièce de rechange de

Réf.	Nom du produit
18-5-B	Extracteur à tirants hydraulique(y compris la vis mécanique)
20-5-H	Extracteur universel à 2 bras avec profondeur réglable et vis hydraulique longue(y compris la vis mécanique)

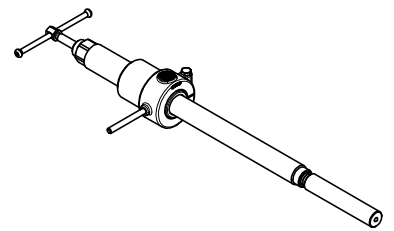
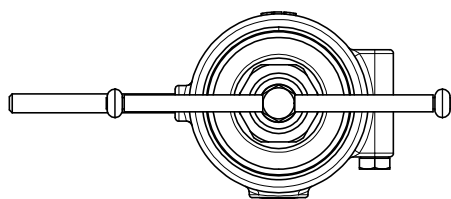
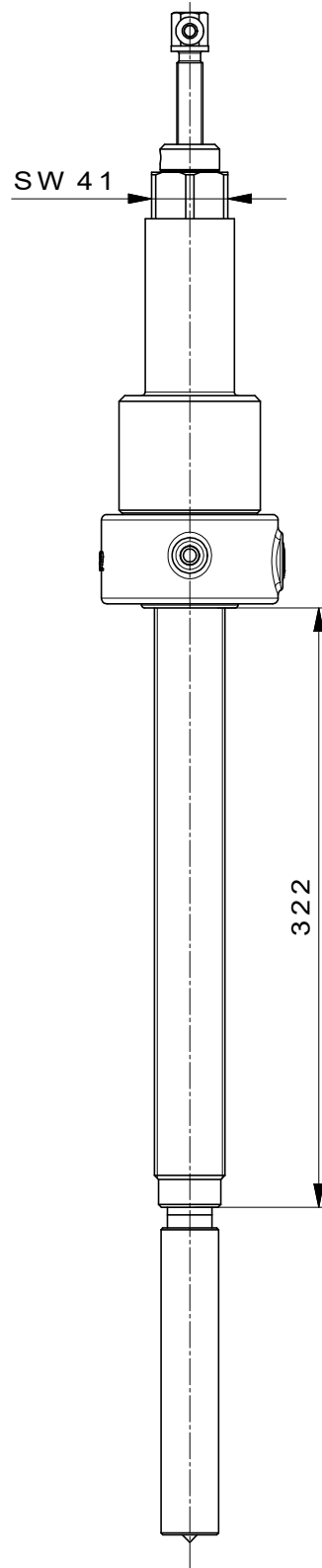
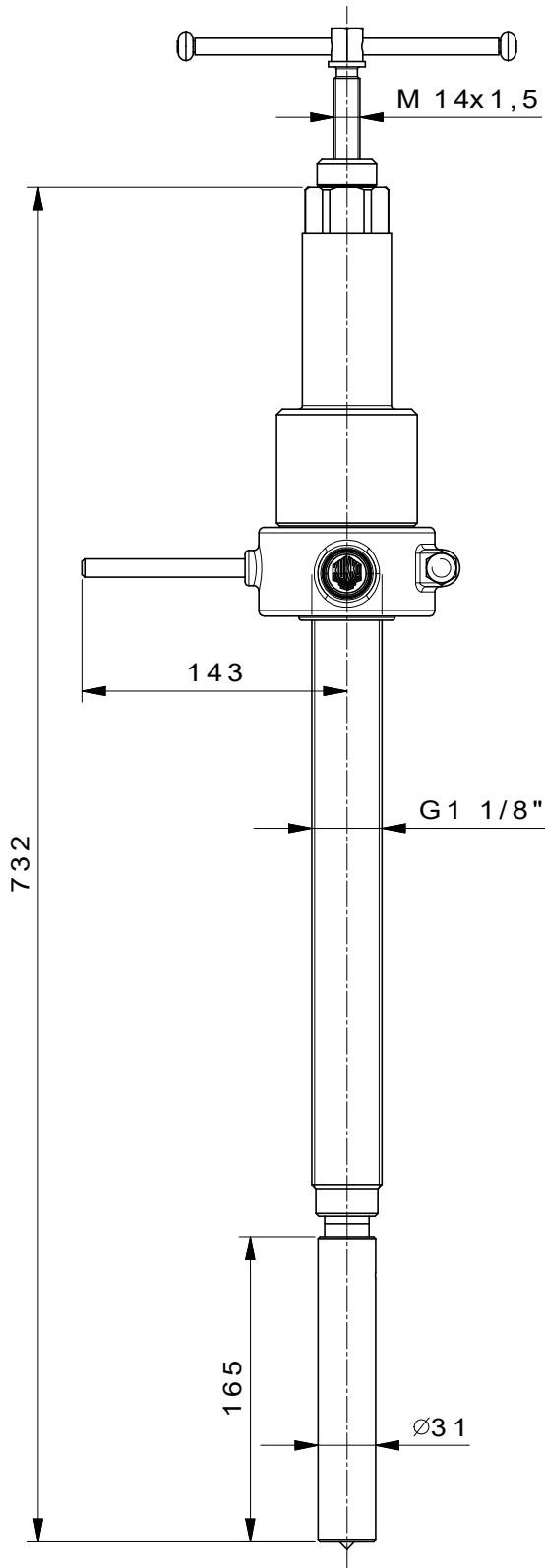

 Kleinbongartz & Kaiser oHG Werkzeugfabrik Hilden - Germany	Dokumentname: 8-2-M_Lange Hydraulikspindel	Toleranz: DIN ISO 2768-m
	Dokumentbeschreibung: BAUGRUPPENZEICHNUNG	Material: Vergütungsstahl/ heat treatable steel
	Erstellt von: Breidenbach	Erstellungsdatum: 19/04/2017
Teilbeschreibung: Lange Hydraulikspindel/ Long hydraulic spindle		Wärmebehandlung / Härte:
		Oberflächenbehandlung:
Artikelnummer / ZNR: 8-2-M	Dokumentversion: -	Schutzvermerk ISO 16016 beachten