



商品名

## スライドハンマー

22-0と22-0-1の場合のみ、シリーズ21、シリーズ21-E、シリーズ22-1-ASと併用。







商品番号 KS-22-01-GH

シリーズ 22-0

JANコード 4021176269073



技術属性	メートル	インペリアル
 スライドハンマーの全長	290 mm	11 3/8 inch
 打撃質量	0,9 kg	1.98 lbs
 スライドハンマーの衝撃重量	215 mm	8 1/2 inch
 スライドハンマーの柄の接続ネジ	M12	M12
 重量	1.215 kg	

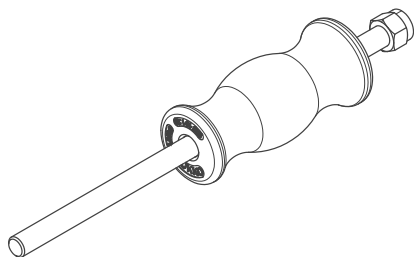
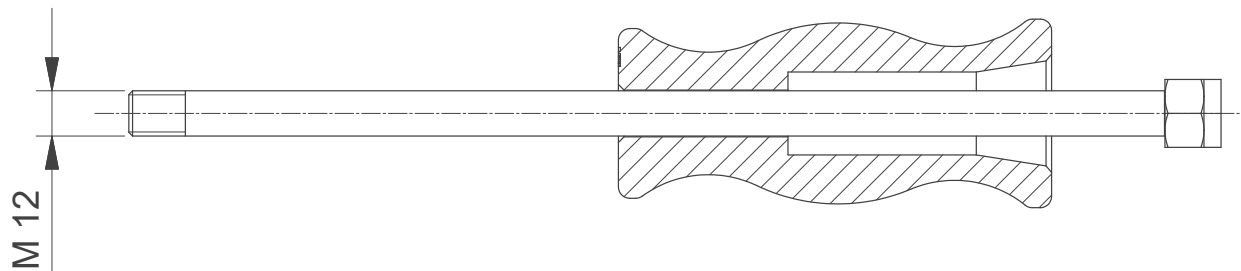
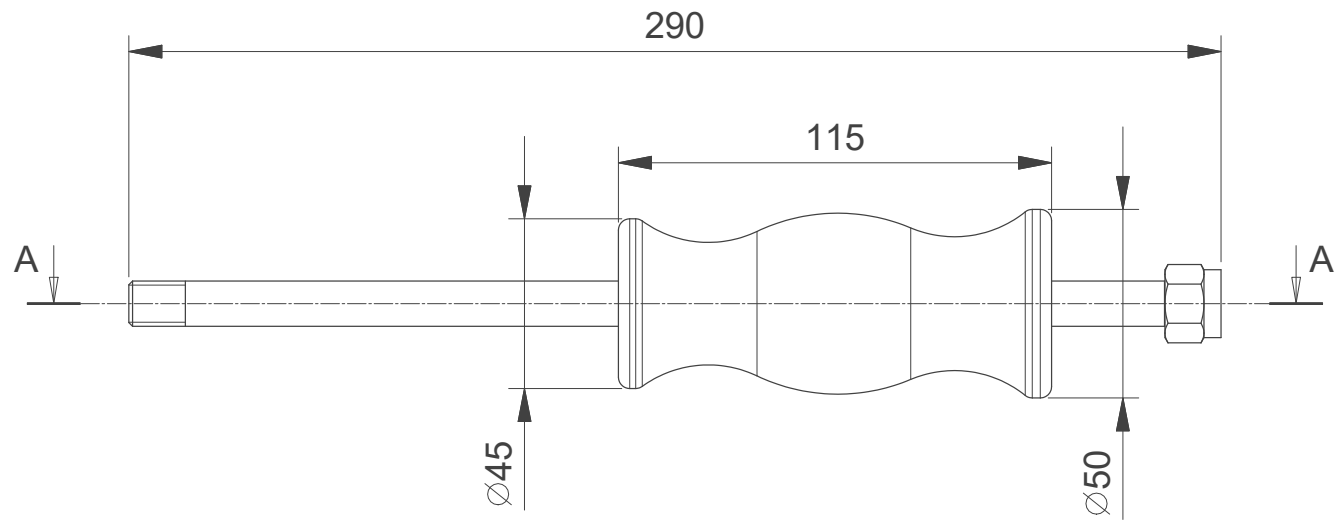

 <b>Kleinbongartz &amp; Kaiser oHG</b> <b>Werkzeugfabrik Hilden - Germany</b>	Dokumentname: <b>KS-22-01-GH_Gleithammer 0,85kg</b>		Toleranz: <b>DIN ISO 2768-m</b>
	Dokumentbeschreibung: <b>Baugruppe</b>		Material: <b>Vergütungsstahl/ heat treatable steel</b>
	Erstellt von: <b>Breidenbach</b>	Erstellungsdatum: <b>05/10/2017</b>	Maßstab: <b>1:2</b>
Teilbeschreibung: <b>Gleithammer 0,85kg/ slide hammer 0,85kg</b>		Wärmebehandlung / Härte: -	
		Oberflächenbehandlung: -	
Artikelnummer / ZNR.: <b>KS-22-01-GH</b>	Dokumentversion: -	Schutzvermerk <b>ISO 16016 beachten</b>	