



Nome do produto

Martelos deslizantes

Para a utilização com as séries 21 e 21-E. Série 22-1-AS apenas para 22-0 e 22-0-1.





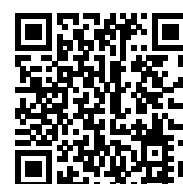

Artigo Nº KS-22-01-GH

Série 22-0

EAN 4021176269073



	Características	Métrico	Polegada
	Comprimento total do martelo deslizante	290 mm	11 3/8 inch
	Massa de impacto	0,9 kg	1.98 lbs
	Trajatória de impacto do martelo deslizante	215 mm	8 1/2 inch
	Roscas de ligação da barra do martelo deslizante	M12	M12
	Peso	1.215 kg	

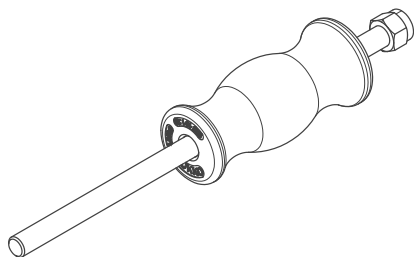
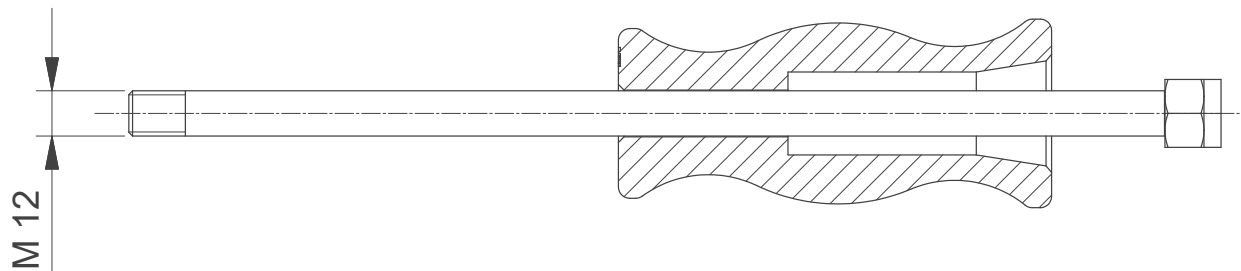
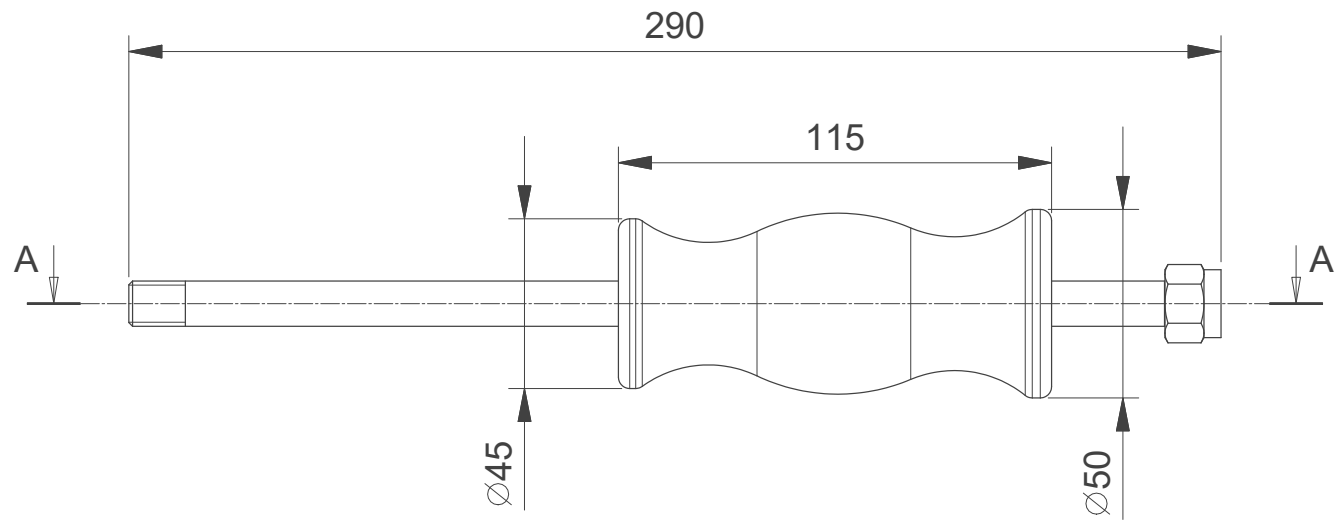

 Kleinbongartz & Kaiser oHG Werkzeugfabrik Hilden - Germany	Dokumentname: KS-22-01-GH_Gleithammer 0,85kg		Toleranz: DIN ISO 2768-m	
	Dokumentbeschreibung: Baugruppe		Material: Vergütungsstahl/ heat treatable steel	
	Erstellt von: Breidenbach	Erstellungsdatum: 05/10/2017	Maßstab: 1:2	
Teilbeschreibung: Gleithammer 0,85kg/ slide hammer 0,85kg			Wärmebehandlung / Härte: -	
			Oberflächenbehandlung:	
Artikelnummer / ZNR.: KS-22-01-GH	Dokumentversion: -		Schutzvermerk ISO 16016 beachten	